

hanström

3-in-1 Boiling Water Tap

Installation Manual

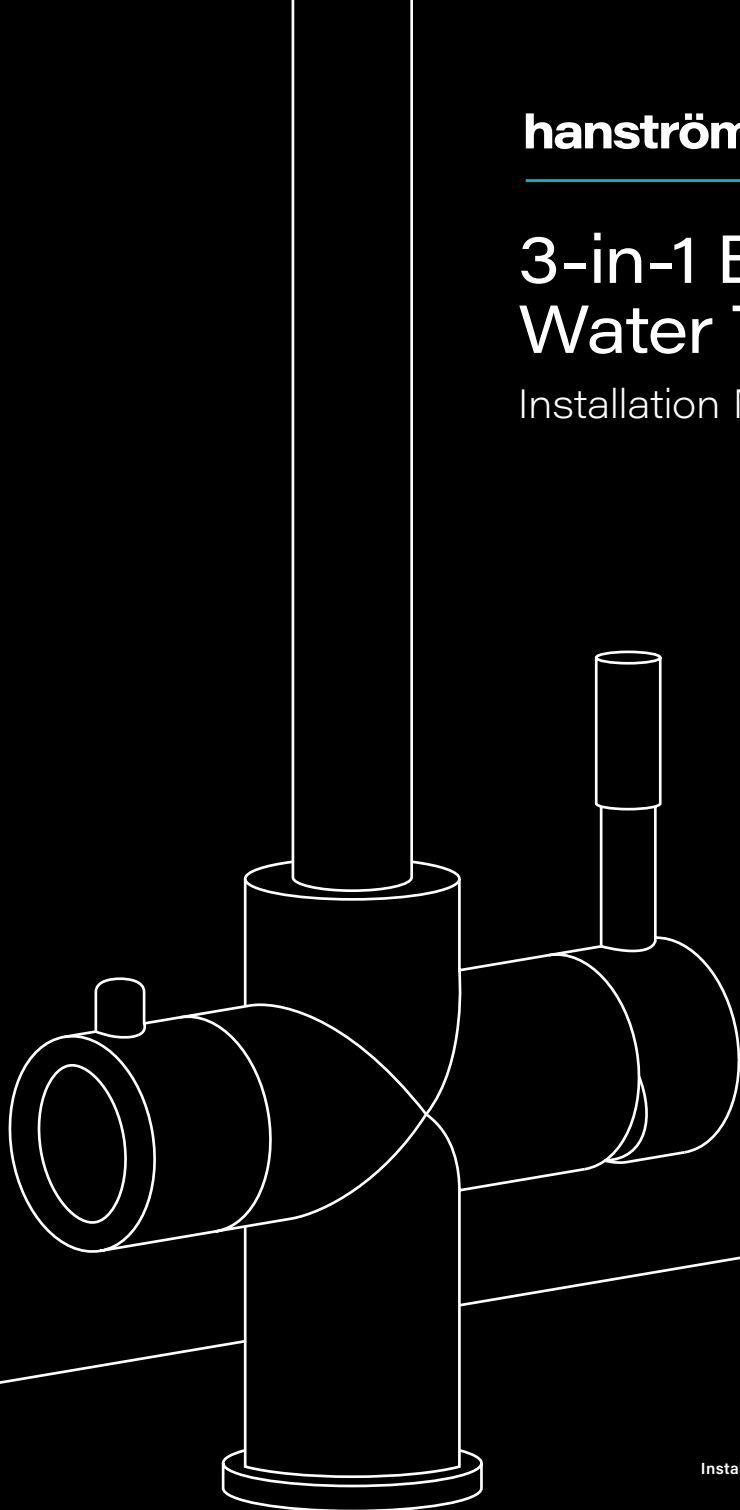

Installation for all 3-in-1 models

Contents

Components List	4
What You Need to Know	5
Safety Instructions	6 - 7
Installation Requirements	8
Preparation for Installation	9
Installation	10 - 16
Maintenance & Care Instructions	17
Trouble Shooting	18 - 19

Component List

Not to scale

Boiler Box

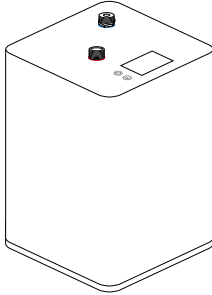

Boiler Unit



G 3/8" female & G 1/2" male adaptor



G 1 3/8" female & quick connection adaptor

Tap Box



Tap Base



Gasket

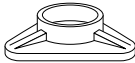

Retaining Plate

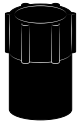

Fixing Nut



Threaded Tube

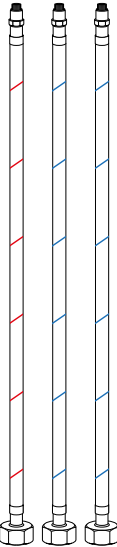

3x Water Hose -
2x Cold,
1x Hot

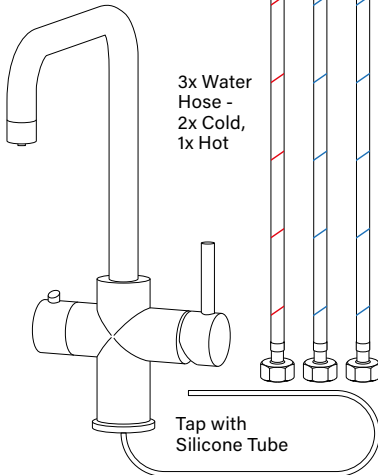

Tap with
Silicone Tube

Filter Box

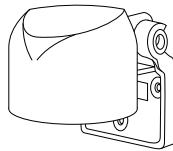

Filter Cap

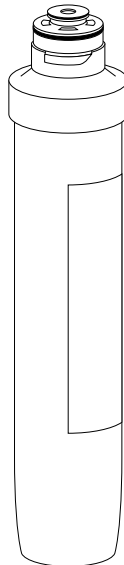

Filter Unit

PVC Pipe



G 1/2" male & PE tube adaptor



G 1/2" female & PE tube adaptor



What You Need to Know

For your safety and satisfaction please read all the instructions, cautions and warnings before installing or using this electronic instant hot water appliance.

This electronic instant hot water appliance is not intended for industrial or intense commercial use.

IMPORTANT NOTICE: This product can cause harm if installed incorrectly and should only be installed by a competent person, if you feel for any reason unsure about the installation please contact a qualified plumber or electrician to install the appliance.

Make sure all electrical wiring and connections conform to local standards.

Make sure all water connections conform to local standards.

A standard 220/240v grounded 13 amp switched electrical outlet is required under the sink for the electronic instant hot water appliance electrical power and must supply electrical power continuously to the appliance.

The power outlet must be connected to the 13amp fused plug supplied.

The instant hot water appliance is an open vented system appliance when not being operated the pressure is 1.0bar. The operating pressure is 1.5 bar to 5 bar.

The water filter must be connected to the electronic instant hot water appliance.

Failure to change filter every 6 months may invalidate your warranty.

Equipment Required

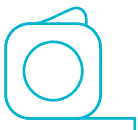

Tape
Measure



Adjustable
Wrench

Safety Instructions - Please Read



WARNING



DANGER

The alert symbols displayed above point to important safety information to make you aware of potential hazards that can cause serious injury or death. Please pay special attention to the information following these warning alerts. Failure to comply with these instructions could result in property damage, serious injury or death.

Please read this chapter carefully for your own safety and the safety of those around you. Please read the safety information in this instruction, installation guide and on the product in order to install and use the product accordingly, so as to avoid any injury. The safety information will tell you what the potential danger is, how to avoid it, and identify what will happen if you do not operate following the instruction.

Electric Shock

Electric Shock: Using an ungrounded connection or improper connection of the power supply to the product can result in a serious injury or death from electrical shock.

Electric Shock:

- Do not remove the earthing terminal
- Do not reconstruct the plug
- Do not disassemble main box and any part for the power.



WARNING



DANGER

IMPORTANT: The instructions are only intended as a guide, if there is any doubt then please contact a certified plumber or electrician or point of purchase and avoid using the product until it has been checked.

Safety Instructions - Continued



When using all electrical appliances, basic safety precautions should always be followed including the information below:

To protect against electrical shock, do not place cord, plugs or unit near or in water or other liquids and do not operate the electronic instant hot water appliance controls or power socket with wet hands.

Check the power rating of your electronic instant hot water appliance is suitable for the power rating of the electrical circuit it is being installed on.

Do not operate or install the electronic instant hot water appliance if it appears to have any missing parts, be damaged or faulty e.g. damaged cord, plug.

Do not use outdoors or in a damp area.

Do not use the electronic instant hot water appliance for anything other than the intended Domestic use.

The electronic instant hot water appliance must be installed vertically with inlet and outlet connections at the top of the appliance.

Ensure the front of the unit is visible and the front temperature dial can be easily reached.

Do not attempt to open, modify or service this electronic instant hot water appliance. Repairs should be carried out by Authorised Service personnel. Opening the unit may void the guarantee.

The instant hot water appliance is an open vented system appliance when not being operated the pressure is 1.0.bar. The operating pressure is 1.5 bar to 5 bar.

Turn off all controls before unplugging.

Do not unplug by pulling the cable. To unplug, grasp the plug, not the cable.

Property Damage: To avoid the risk of flooding, regularly inspect the unit for any signs of leakage.

This electronic instant water appliance is not intended for use by persons (including children) with reduced physical, sensory or mental capabilities, or lack of experience and knowledge, unless they have been given supervision or instruction concerning use of the appliance by a person responsible for their safety. Children should be supervised to ensure that they do not play with the electronic instant hot water appliance or instant hot water tap, a safety spring back handle is used to control the flow of the near boiling water for additional safety.

Installation Requirements



WARNING Electrical Requirements

A 220/240-volt, 50 Hz, AC -only 13 amp fused, grounded electrical power supply is required. It is recommended that a separate circuit serving only electronic instant hot water appliance be provided or use an outlet that can be turned on/off by a switch.

This electronic instant hot water appliance is equipped with a power supply cord with a power plug. To minimise possible shock hazard, the cord must be plugged into mating, ground-type outlet, grounded in accordance with all national and local codes and ordinances. If a socket outlet is not available, it is the responsibility and obligation of the customer to have a properly grounded outlet installed by a qualified electrician.



WARNING Water Supply Requirements

If local codes permit, the instant hot water tap feed line should be connected to the hot and cold water supply line using isolation valves or another means for providing the hot and cold water to the tap.

IMPORTANT: If local codes do not permit the use of isolation valves, special feed valves can be obtained from your local plumbing supply distributor.



WARNING Environment Requirements

Don't install the electronic instant hot water appliance outdoors or in location that may fall below 0°C, otherwise the pipes and the tap will be frozen and there will be serious safety trouble, possible bodily injury, accidents and damage caused.

It's forbidden to wash the electronic instant hot water appliance with water directly.

The installation environment should be ventilated, with protection from the direct sunshine.

When installing the electronic instant hot water appliance, provide approximately 10cm to 15cm (4-5 1/2") of air space on the sides of the unit for air circulation and approximately 2.5cm(1") from the mounting wall.

The environment humidity should be in the range of 10% to 60%.
Be sure there is no dew.

Installation Requirements - Continued



WARNING Instant Hot Water Tap Information

Connecting a standard tap may cause injury and will damage the electronic instant hot water appliance and void the guarantee. Due to high water temperature, and for safety reasons, the electronic instant hot water appliance is not under pressure.

Preparation for Installation

Unlike other household hot water appliances, this electronic instant hot water appliance is Non Pressurised for safety reasons. For this electronic instant hot water appliance, the **Instant Hot Tap** is placed before the electronic instant hot water appliance, creating an “open vent” system and consequently no pressure is built up inside the appliance.



WARNING

IMPORTANT: Install the Instant Hot Water Tap in accordance with the fitting instructions provided with the Hot Water Tap.

Preparation for the electronic instant hot water appliance installation.

IMPORTANT: Observe all local governing codes and ordinances.

The electronic instant hot water appliance must be mounted vertically and level.

Before you begin, select a suitable location ideally directly under the instant hot water tap or close to it to ensure the connection pipes will connect from the instant hot water tap to the electronic instant hot water appliance.

The electronic instant hot water appliance is not under pressure, consequently, there is a slight delay in water flow after the Hot Water Handle has been turned on. This is normal and indicates that the electronic instant hot water appliance is functioning properly.

It is recommended that you have access to a separate power circuit serving only your electronic instant hot water appliance. See previous pages for more information on “ELECTRICAL REQUIREMENTS”.

Ensure that the electronic instant hot water appliance is placed so that you will be able to view and reach the touch control on the front face for adjustments.

Installation



Step 1 - Position the Instant Hot Water Appliance

Ensure the electronic instant hot water appliance is NOT connected to the Electric Power during installation.

Place the electronic instant hot water appliance in position and check to ensure that the instant hot water tap connection pipes and the power cord will reach without being stretched.

The electronic instant hot water appliance must be positioned so the tubes from and to the instant hot water tap do not twist or kink.

Step 2 - Connect Tap

The electronic instant hot water appliance inlet connection is a 3/8" BSP male threaded connector. The outlet connector is 3/8" BSP male thread connected to a push on connector.

Check the connections type and size on the instant hot water tap for the inlet connections.

Fitting a pressure reducing valve to the cold mains inlet if the mains pressure is above 5bar. The fittings have silicone/rubber washers - **Do not over tighten**. This could cause washers to split.

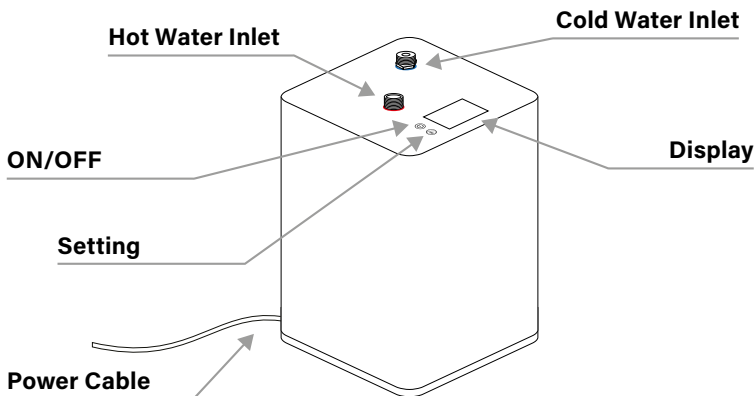

Installation - Continued

Installation Procedure

1. Slide the gasket and white retaining plate on to the threaded tube. Feed the 3 hoses through the threaded tube.

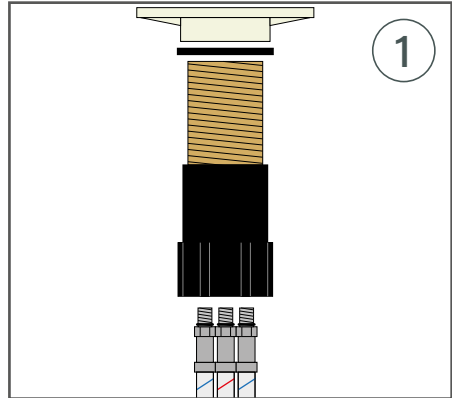

2(a). Feed the 3 hoses through the tap hole from below.

2(b). Place the tap base ring over the 3 hoses. Then feed the silicone tube (attached to the tap) through the tap hole.

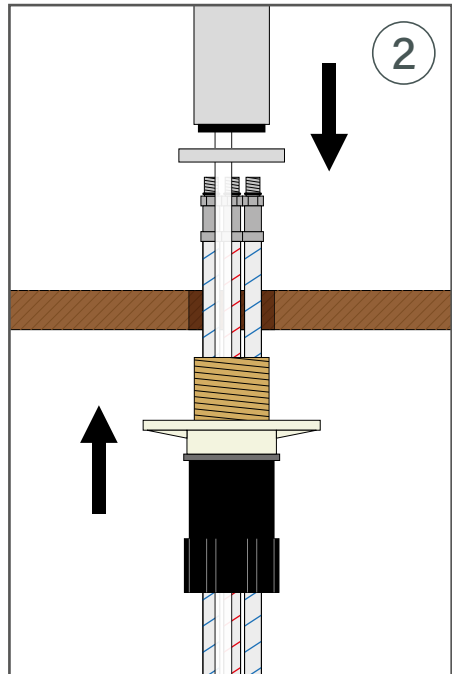

Installation - Continued

3. Install the 3 hoses into the tap following the guide below then tighten the black fixing nut firmly to hold the tap in place.

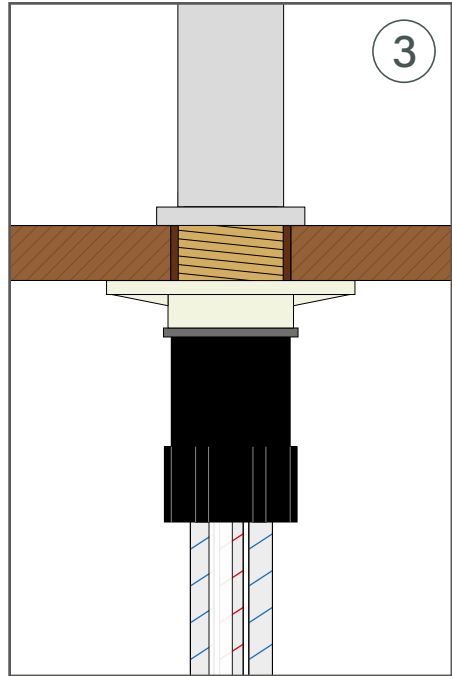
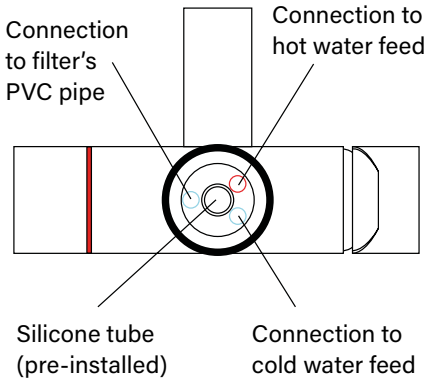

4. Connect the flexi tail marked 'water to boiler' to the filter using the plastic 1/2" to push fit connector and the 6mm PVC pipe.

The 6mm PVC pipe for the filter will come as one length. You will need to cut the pipe into two sections to allow positioning of the filter. We suggest using a plastic cutter as this will leave no swarf. Regardless of the cutting method that you use there must be no debris or swarf allowed to enter the tank as this has potential to cause the unit to fail.

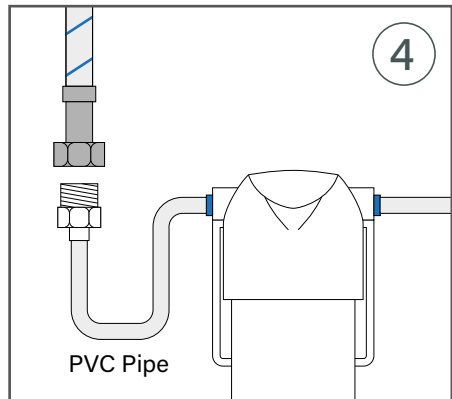

Installation - Continued

5. Connect the hoses.

Note: The washers may already be inside connectors in step 5.

5(a). Connect cold water hose to cold water pipe and hot water hose to hot water pipe.

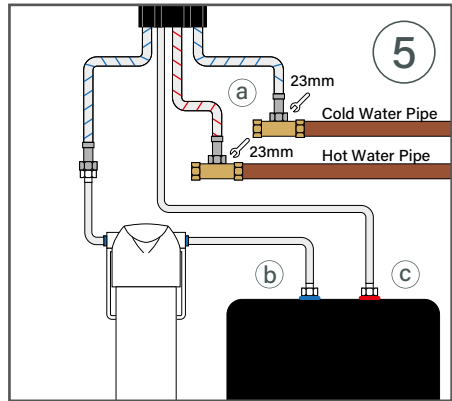

5(b). Connect hose for cold water from tap to boiler.

Connect the metal 3/8" to 1/2" connector on to the threaded spigot coming from the boiler marked in blue. You must use the washer provided. Then connect the plastic 1/2" to push fit connector on top of the metal 3/8" to 1/2" connector. You must use the washer provided. Then push fit the PVC pipe into the push fit connector on the spigot marked with blue and into the filter.

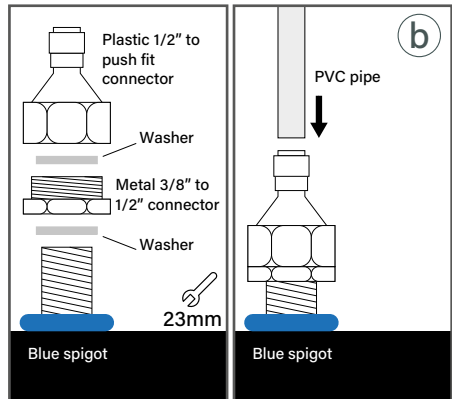

5(c). Connect hose for boiled water from boiler to tap.

Place the metal 3/8" to barb connection on to the spigot coming from the boiler marked in red. You must use the washer provided. Connect the silicon hose to the barbed connection on the spigot marked with red. Secure with the securing clip.

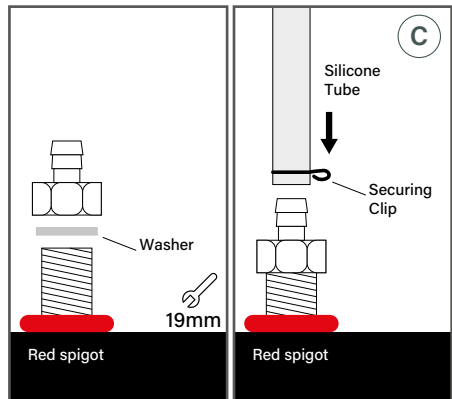

Installation - Continued

Filling and Venting the Heating Tank

1. Close the boiling water tap.
2. Open the mains valve.
3. Open the boiling water valve to fill in the tank until water flows out from the tap.
4. Wait until water flows from the tap.
5. Let the water flow for 3 minutes until clear water flows from the tap.
6. Check for leaks, rectify as necessary.

The Installation Diagram

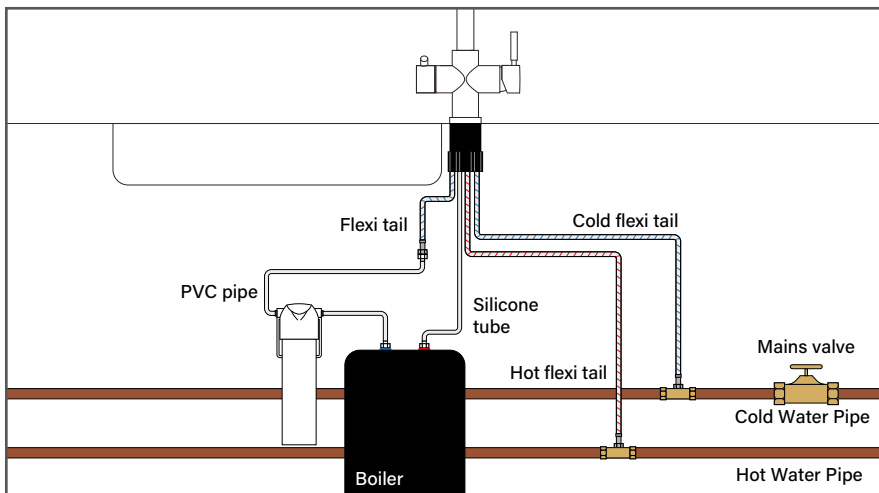

Step 3 - Priming and Checking for Water Tightness

Before the electronic instant hot water appliance is plugged into the power socket it must be tested for water tightness and no leaks.

Open all water valves to allow water to flow to the instant hot water tap. Turn the spring back instant hot water handle and hold to fill the electronic instant hot water appliance, this will take about 2 minutes.



MIXER PART

≤ 5 bar

≤ 70°C

BOILING WATER PART

≤ 3 bar

≤ 110°C



WARNING



DANGER

When the electronic instant hot water appliance is full, water will flow from the instant hot water tap spout. Allow water to flow for 3 minutes so that the water runs clear.

Turn the instant hot water handle off and check all connections for water tightness and leaks.

Any leaking joint must be tightened to ensure no water leakage and the above priming undertaken again and checked for water tightness before connecting to the power socket.

Step 4 - Connect to the Power

Connect the plug to the power socket and turn on the power socket at the switch. The electronic instant hot water appliance display panel will now light up with the on/off.

Step 5 - Electronic Control Display Panel



ON/OFF to control the power. The Light will illuminate red.



Temperature setting: press to select one of five temperature: 75°C, 85°C, 90°C, 95°C, 98°C

The left-hand temperature will show the current temperature of the water. The right-hand temperature will show the selected temperature.

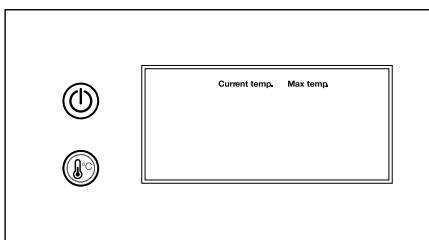

Fault Codes



WARNING

If the electronic instant hot water appliance is empty of water and is turned ON then this will be automatically sensed, the display will show "E3". The tank needs to fill with water through the boiling water control handle on the tap.

When the display shows "E4", please unplug and plug the boiler. If the problem still exists, please contact service centre to have the tank checked and repaired.



DANGER

If the electronic instant hot water appliance is not powered off or filled with water then after approximately 5 minutes the electronic instant hot water appliance will automatically power down until it is primed with water using the instruction set out earlier.

Once the Temperature is set the light will show Red while the tank is being heated. Once the temperature has been reached the light will turn to Green. If there has been a power cut in the property, you will need to reset the temperature of the hot water tank otherwise the water will not heat up.

Operation

Once the temperature is set, the light will flash that signifies that the tank is being heated. The desired temperature and the actual temperature of the water will match when the water has been heated to the required temperature.

To operate the instant hot water side of the tap, press down the lock button and twist away from you. Caution, near boiling water will come from the spout. Release to turn off. To operate the regular mixer side of the tap, pull the lever away from the tap and either pull it toward you for hot water or push it away from you for cold water. To shut off, return the lever to a vertical position.

When there is a power failure or if the unit has been switched off you will need to turn the electronic instant hot water unit on again and re-select the temperature as described previously in this instruction.

When the instant hot water is drawn from the instant hot water tap or the water temperature in the electronic instant hot water appliance falls below the required temperature setting, then it will automatically re heat to the required temperature setting.

To turn off the electronic instant hot water appliance at any time push the  off button.

Maintenance & Care Instructions

Maintenance & Power Saving

If the electronic instant hot water appliance is not being used for long periods of time i.e. over 7 days, to save power we recommend you switch off using the "ON/OFF" switch.

Seasonal Shutdown

The hot water system (tank and tap) must not be exposed to freezing temperatures. If there is a possibility of this, the system must be drained of water. Shut-off the mains supply and unplug the unit from the electricity mains and allow the tank to cool for at least 1 hour. Disconnect the inlet supply to the tank and remove the silicone hose outlet pipe, lift the unit to the sink, turn upside down and drain all the water from the tank. When reinstalling follow the original installation instructions.

Notice

This appliance dispenses 98°C water, fittings & pipework can get hot!

The electronic instant hot water appliance like any water heater has a limited operational life span and will eventually fail. In order to ensure maximum protection and to avoid possible damage to any property or personal injury the electronic instant hot water appliance should be inspected regularly for any water leakage or damage.

Regularly check for any signs of water leakage, if there is any water leakage then replace any loose or spilt silicone tubes or flexi tails which can cause water leakage and damage.

To provide additional water security to avoid property damage the electronic instant hot water appliance can be placed in a drain pan and connected to a suitable drain outlet to avoid any water damage. The drain pan should be installed using the manufacturers installation instructions.

Trouble Shooting

PROBLEM	POSSIBLE CAUSES	WHAT TO DO
Water and Steam is spitting from the instant hot water tap spout.	Unit is boiling.	Turn the instant hot water tap handle on and release the water.
	Pressure is lower than 1.5 bar or higher than 5 bar.	Check the pipe pressure. Check if aerator is blocked and remove the dirt in the aerator.
Water is not hot.	The electronic instant hot water appliance is unplugged.	Make sure the electronic instant hot water appliance is plugged in and connected to a grounded electric outlet.
		Make sure that the circuit breaker and fuse are working correctly.
Water is too hot.	Water temperature setting is set to high temperature.	Re-set the temperature to the lower temperature.
Water is dripping from the instant hot water tap spout.	The expansion chamber isn't draining the system correctly due to very small draw off water.	Draw off 0.5L of water to clear and prime the system. Avoid less than 150ml draw offs of water.
	The spout is blocked.	Remove and clean the aerator.
Slow Flow from the spout.	Water Filter may be clogged from impurities in the inlet mains water.	The water filter must be changed every 6 months or this will void guarantee.
Water does not flow straight away.	The electronic instant hot water appliance is design for non pressurised operation and there will be slight delay till the near boiling water appears.	After a large volume of water has been drawn off there maybe a slightly longer delay in the water appearing from the instant hot water tap spout.
	Pressure is lower than 1.5 bar or higher than 5 bar.	Check the pipe pressure Check if aerator is blocked and remove the dirt in the aerator.

PROBLEM	POSSIBLE CAUSES	WHAT TO DO
No Water Flowing.	Water valves have been turned off.	Turn on all the water valves.
	Inlet Pipes have been twisted or blocked.	Ensure the pipes are not twisted or kinked or restrict flow.
		Remove and clean the aerator.
		Remove the electronic instant hot water appliance as per the de-scaling instructions and flush through all pipes to ensure water flow.
E3 fault code.	The E3 code indicates water shortage protection. When the water level in the inner tank is below the minimum required level 'E3' will appear.	Open the instant hot water tap handle to fill the instant hot water tank.
	If the above does not work and the unit continues to show 'E3', it could be a float switch sensor fault.	Contact the retailer.
E4 fault code.		Power off the unit and unplug from the power source. Then try reinstalling. If this does not solve the issue, contact the retailer.
The boiler causes the electrics within the property to trip.	The electric meter is overloaded, the installation of your instant hot water appliance in addition to the rest of your appliances has exceeded the limit of the RCD protection limit.	Upgrade the RCD protection limit or move the instant hot water appliance on to a different circuit.
Water does not flow straight away.	The boiler could be short circuiting. To test this, unplug all other electric equipment, plug in the boiler and turn on. If the boiler trips the electric this time, the boiler is short circuiting.	Contact the retailer.

IF YOU ARE IN ANY DOUBT THEN POWER OFF THE ELECTRONIC INSTANT HOT WATER APPLIANCE AND CALL THE SERVICE AGENT.

hanström

Tap into the future.